



All pedigrees (family trees) found in the Frazer Lab NHLBI Next Gen Collection are listed in the following document.

The donors depicted in the pedigrees provided by the Frazer Laboratory are denoted as the last numbers of the cell lines names. For example, UCSD###i-YY-Z indicates YY is the family ID and Z is the donor ID. A specific example of UCSD003i-16-2 is found in family 16, and is referred to as 16_2.

First locate the family number and then within the pedigree, locate the donor.

If the family number is not on the document, the donor is not part of a pedigree within this collection.

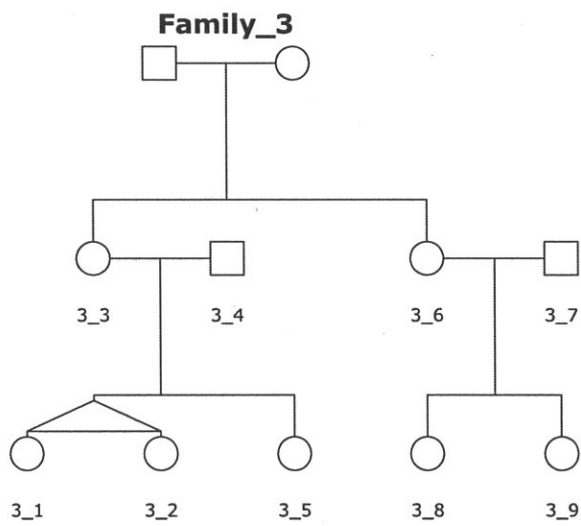
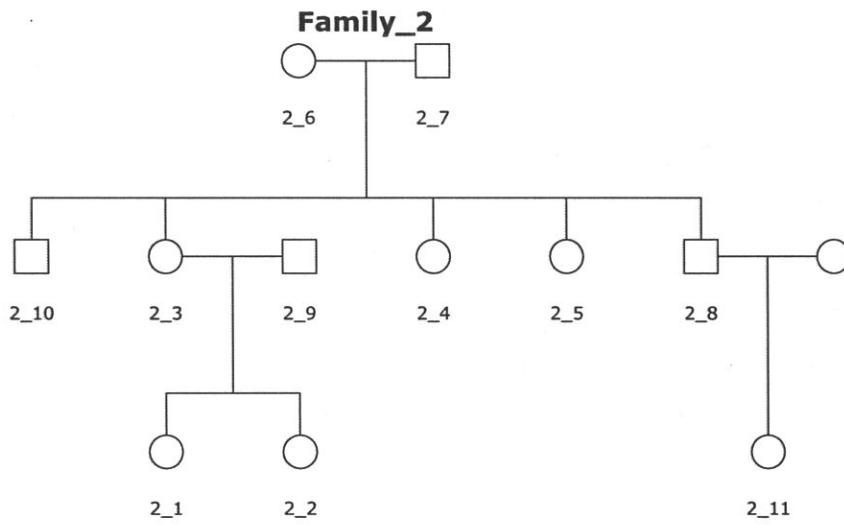
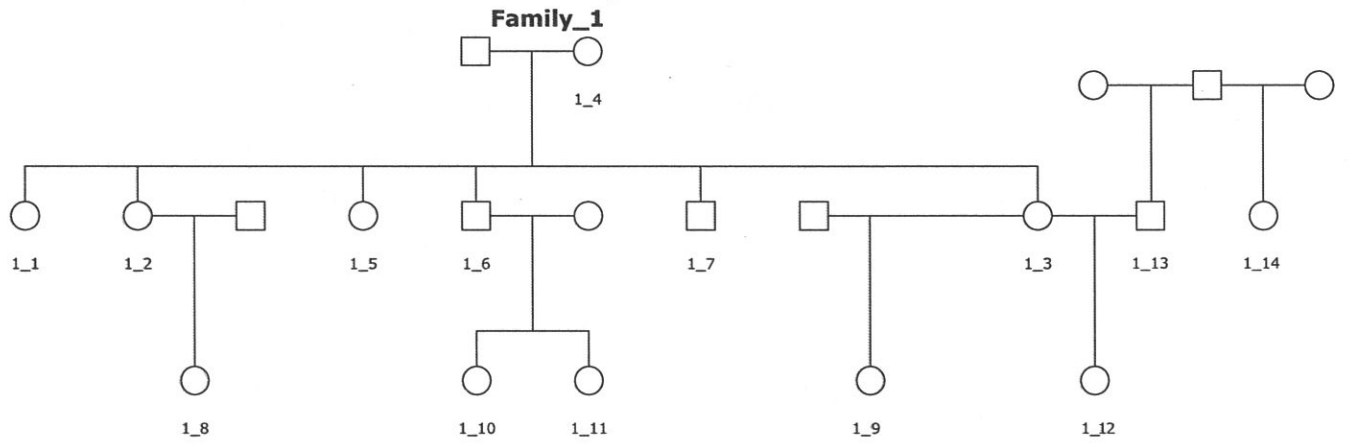

Family_4

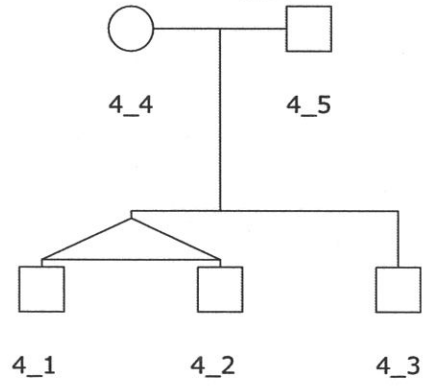

Family_5

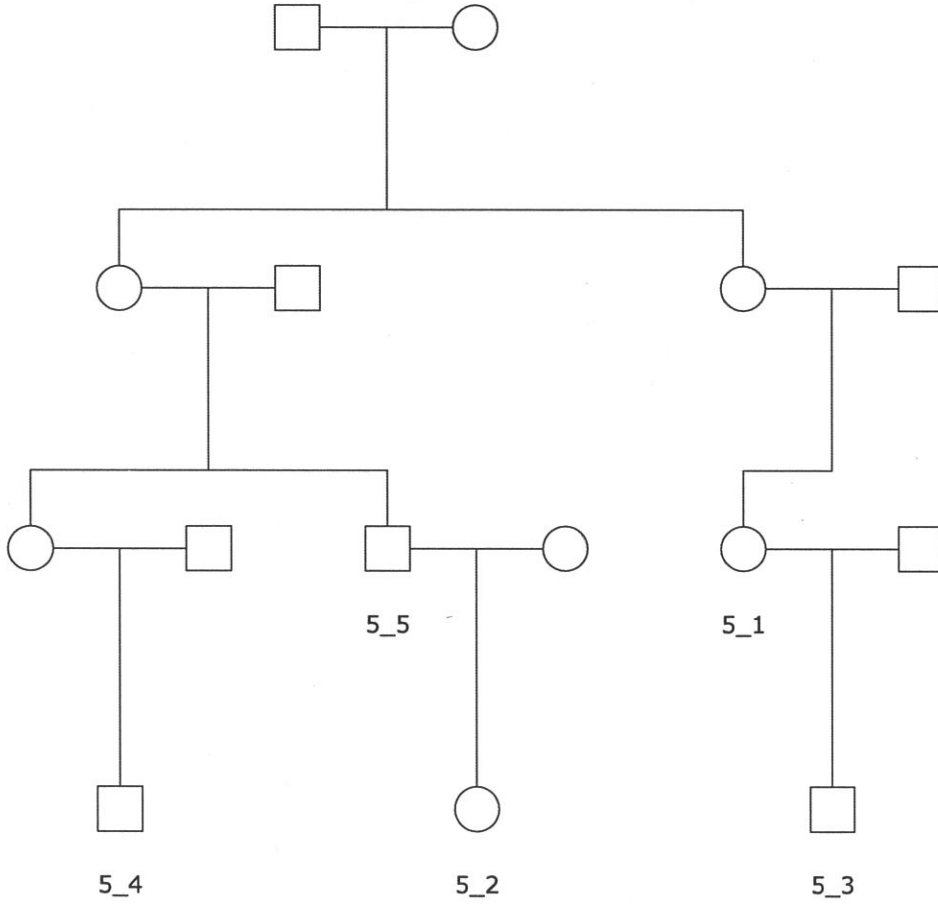

Family_6

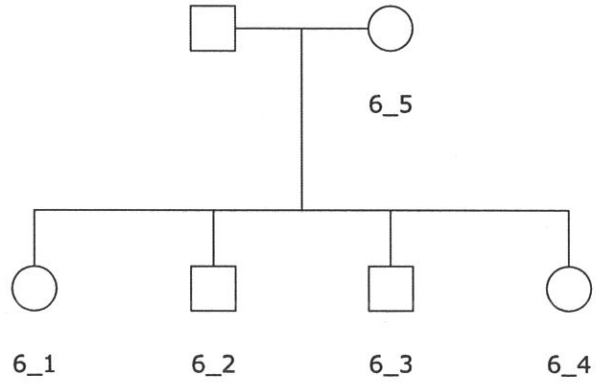

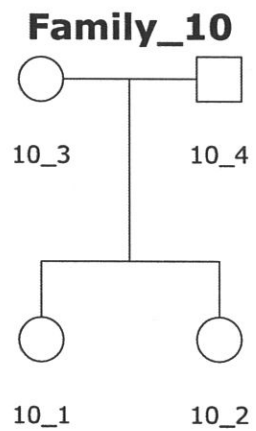
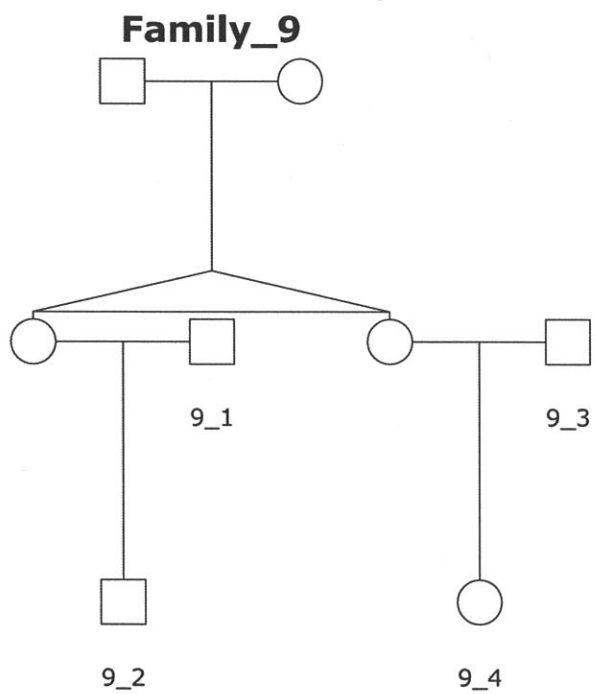
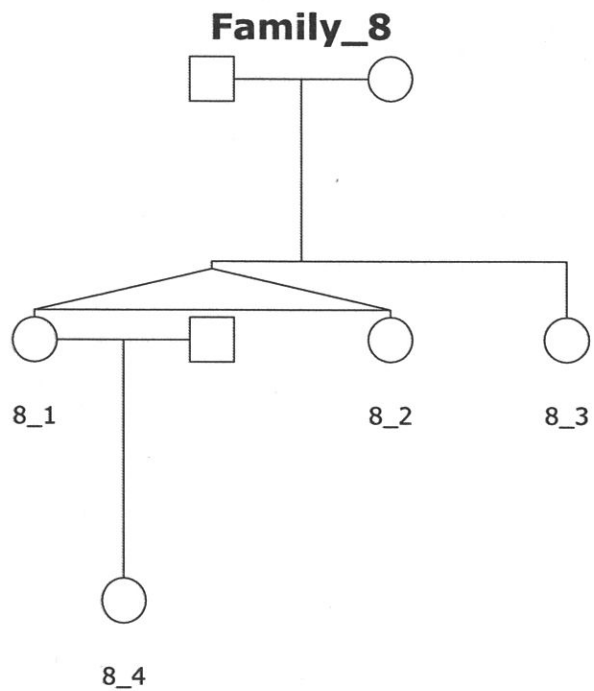
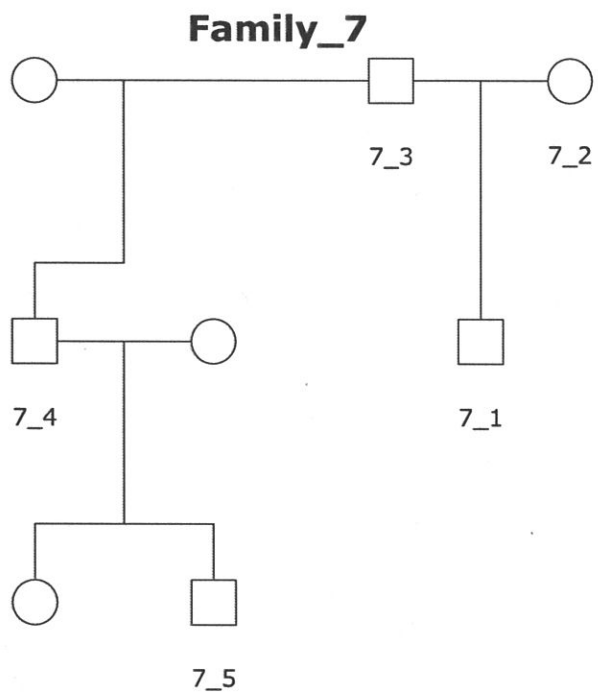

Family_11

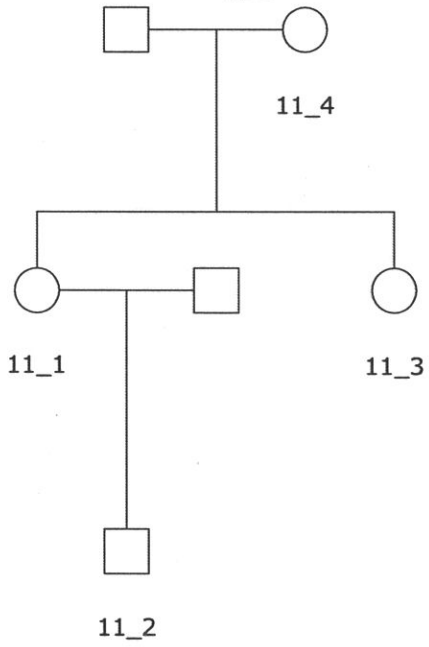

Family_12

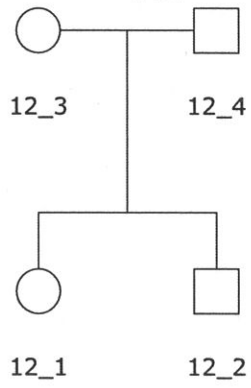

Family_13

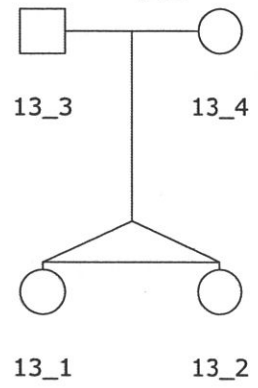

Family_14

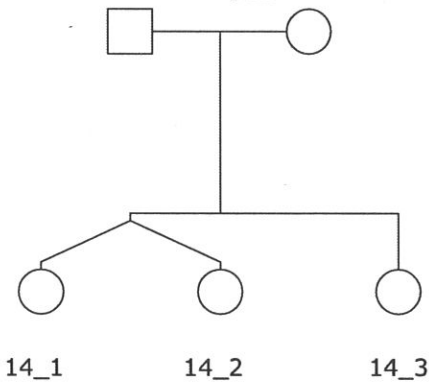

Family_15

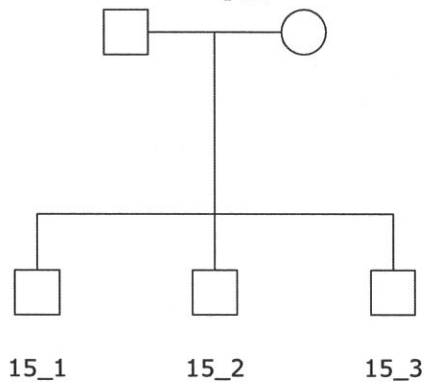

Family_16

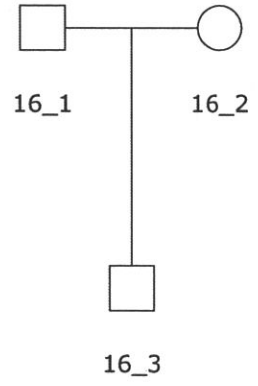

Family_17

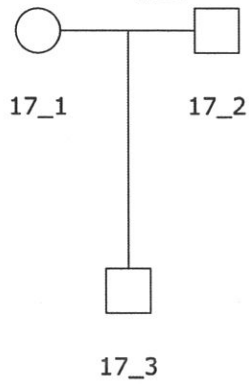

Family_18

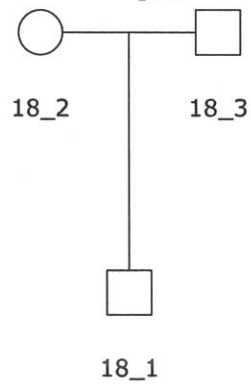

Family_19

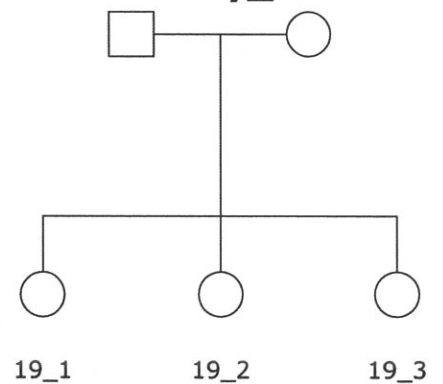

Family_20

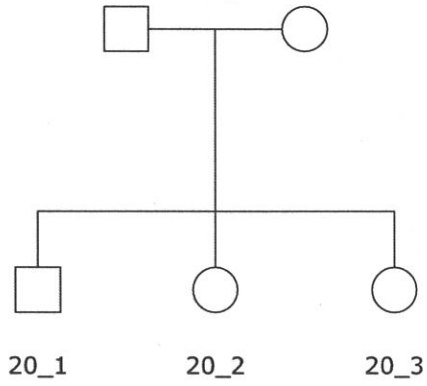

Family_21

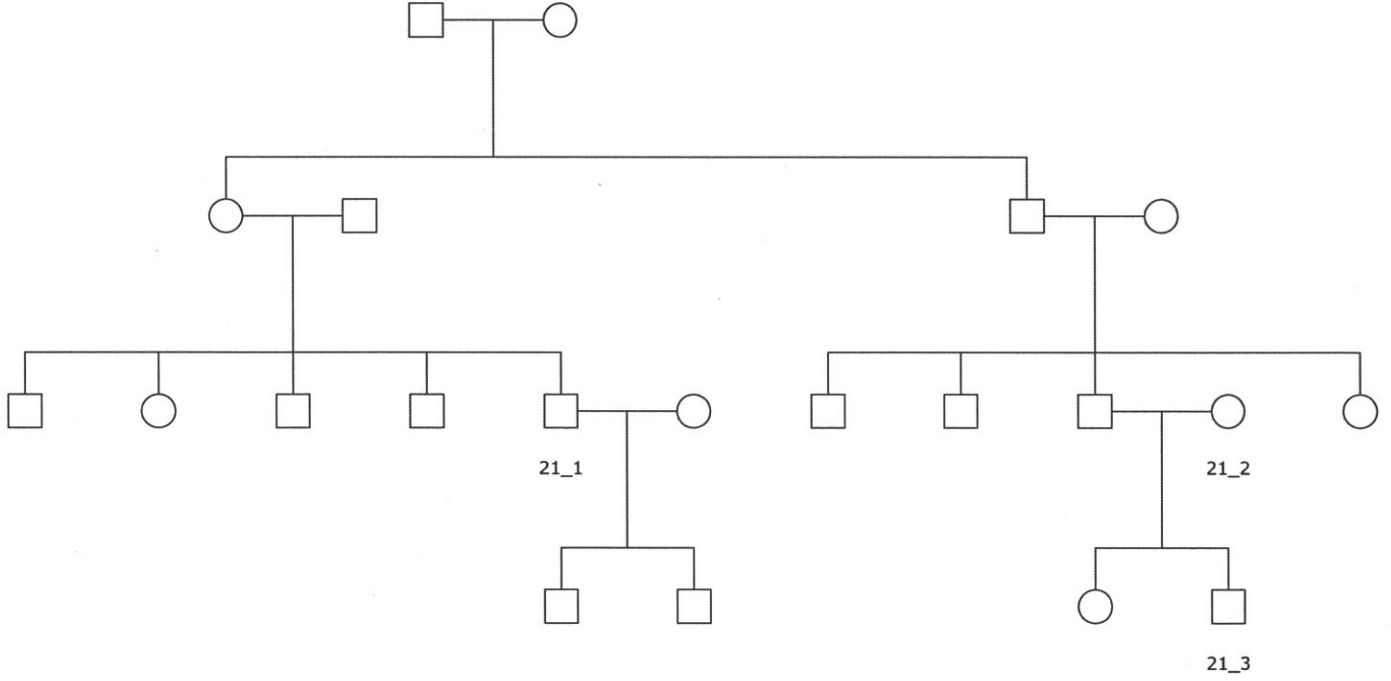

Family_22

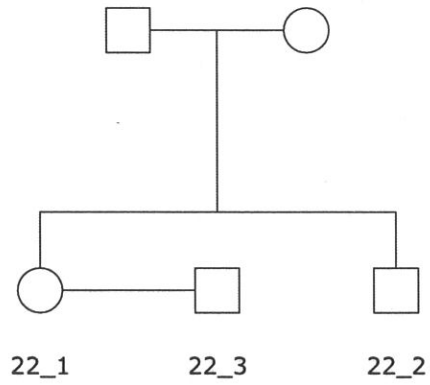

Family_23

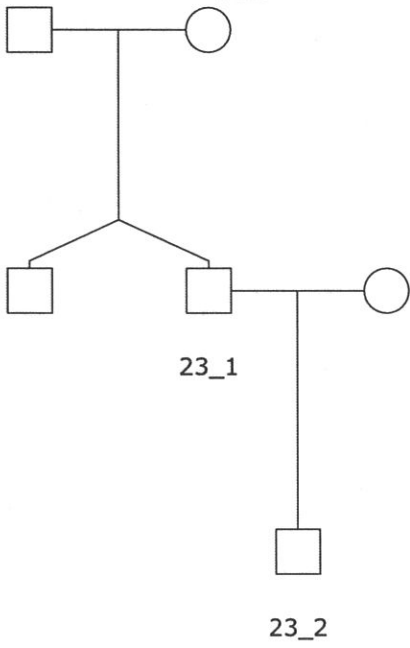

Family_24

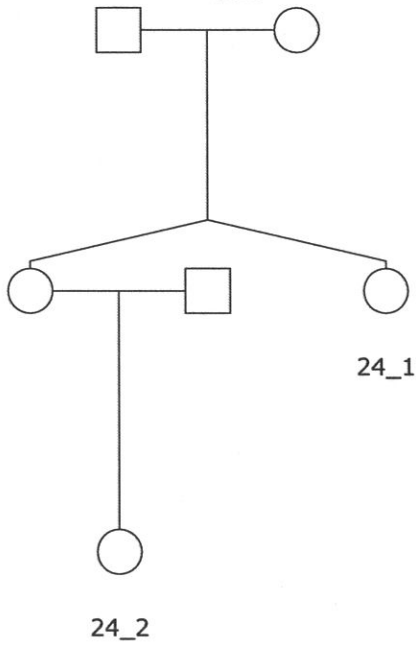

Family_25

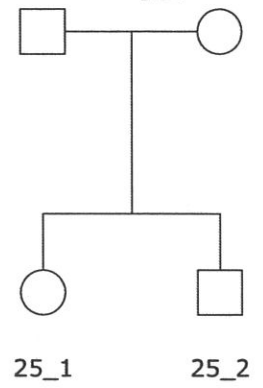

Family_26

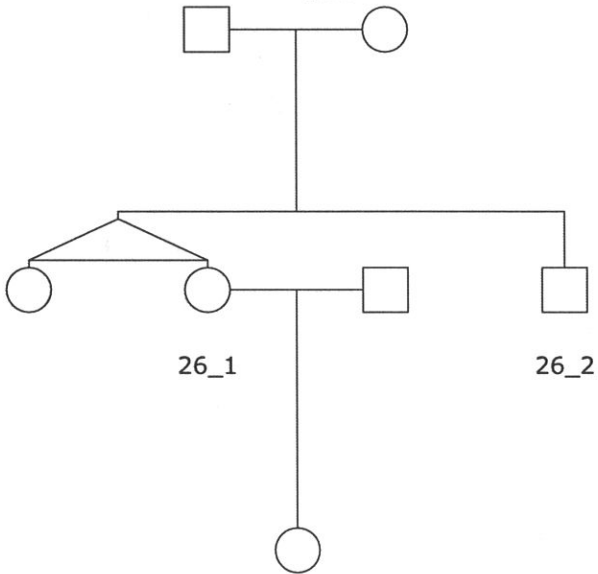

Family_27

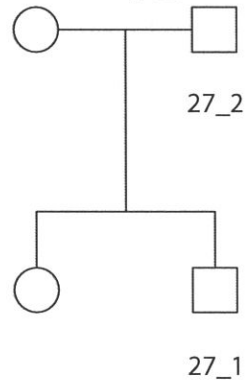

Family_28

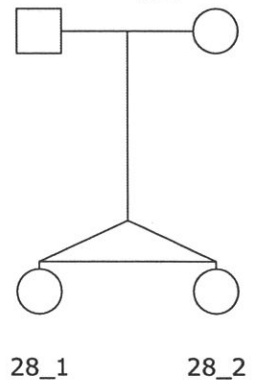

Family_29

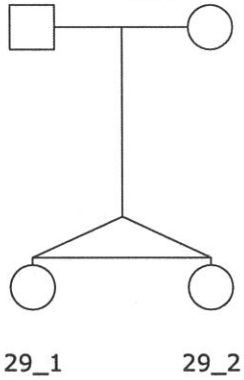

Family_30

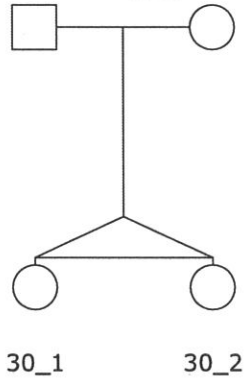

Family_31

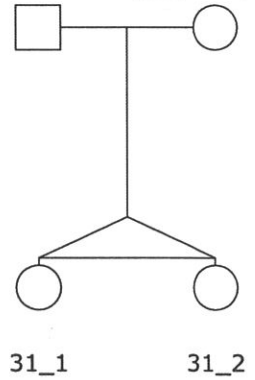

Family_32

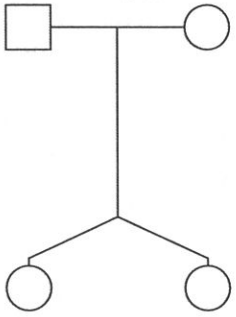

32_1 32_2

Family_33

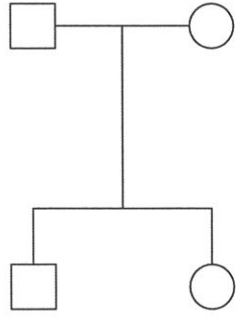

33_1 33_2

Family_34

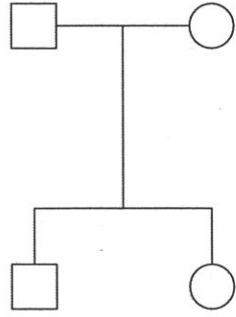

34_1 34_2

Family_35

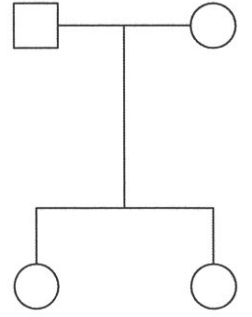

35_1 35_2

Family_36

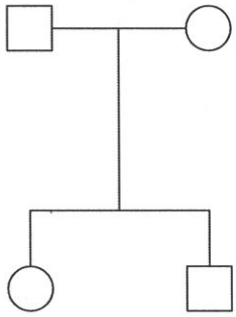

36_1 36_2

Family_37

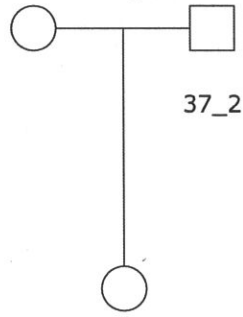

37_1

37_2

Family_38

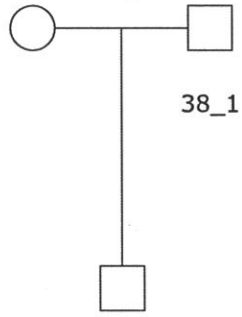

38_2

38_1

Family_39

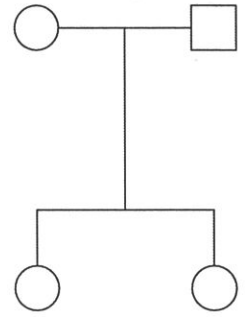

39_1 39_2

Family_40

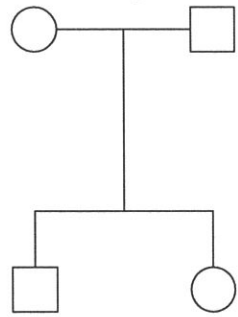

40_1 40_2

Family_41

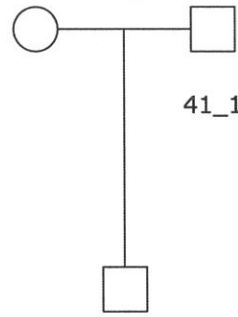

41_2

41_1